

Technical specifications

Power supply	208-277V
Maximum continuous exposure temperature (power on)	65°C
Maximum intermittent exposure temperature, 1000 hours (power on or off)	85°C
Minimum installation temperature	-40°C
Protective braid resistance	< 18.2Ω/km
Bus wire gauge	20AWG
Approvals	ETL / EAC / CE

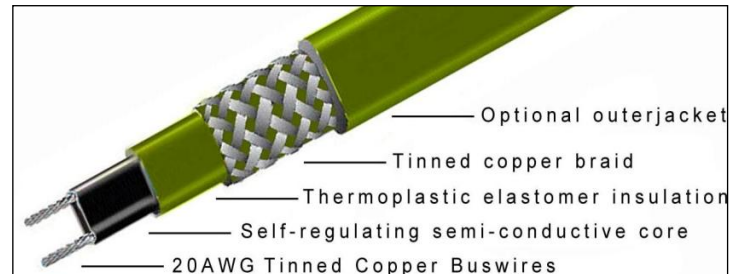

Options

- HGM...C** Tinned copper braid provide additional mechanical protection and a positive ground path
- HGM...CR** Flame retardant thermoplastic outer jacket protect against certain inorganic chemical solutions. It also protect against abrasion and impact damage.
- HGM...CT** High Temperature Fluoropolymer outer jacket are used for exposure to organic or corrosive solutions or vapor may be present.

Description

HGM is a parallel self-limiting heating cable used for freeze protection and temperature maintenance of pipes, valves, flanges and tanks. Self-limiting heating cables increase or decrease the heat output depending on the change of ambient temperature. Because of this a thermostat is not always necessary, the heating cable will never over heat. Heating Group International can provide all the calculations and engineering, the heating cables, accessories as termination kits and all the control equipment.

Features

- Energy efficient, automatically varies its power output in response to pipe temperature changes.
- Easy to install, can be cut to any length (up to max circuit length).
- Lower installation costs than steam tracing. Less maintenance costs and downtime.
- No overheat or burnout even when overlapped.
- Suitable for use in non hazardous and corrosive environments.

Weight and dimensions

Type	Dimension	Min. Bending radius	Weight (kg/100m)
HGM...C	6,7x3,2mm	29mm	6,0
HGM...CR	8,3x5,7mm	34mm	7,5
HGM...CT	7,7x5,1mm	30mm	7,1

Product ordering information

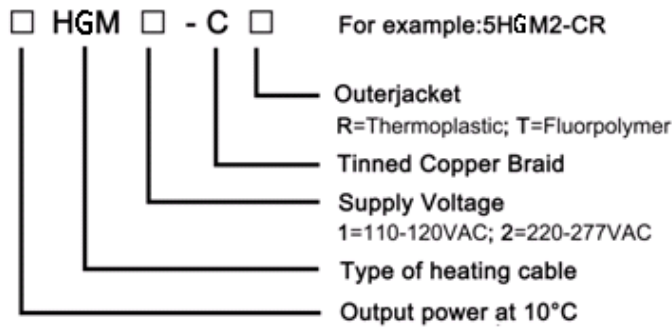

Power output curves

Nominal power output at 230V when HGM installed on insulated metal pipes.

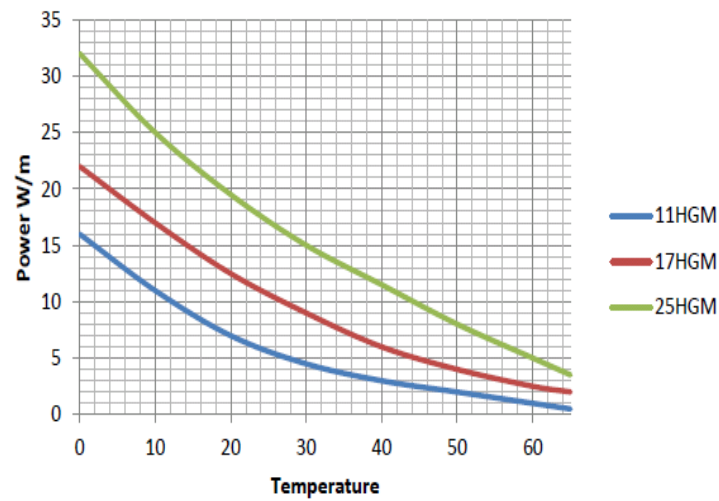

Maximum length (m) vs circuit breaker size

Minimum start-up temperature	CB size Amps	11HGM	17HGM	25HGM
		230V m	230V m	230V m
10°C	10	128	100	75
	16	128	112	90
	25	128	112	92
0°C	10	123	85	65
	16	128	102	88
	25	128	112	92
-20°C	10	81	56	34
	16	115	88	51
	25	128	102	70
-40°C	10	60	42	26
	16	96	68	34
	25	105	86	56

www.heatinggroup.eu

hgi@heatinggroup.eu

+3124-3434222